

BEYOND

CE₀₁₉₇

**BEYOND ResPlus C-20A CPAP
User Manual**

Please read this manual carefully before using this product

User Manual

The following document is the User Manual for the BEYOND ResPlus C-20A CPAP (“C-20A CPAP” or “the device”) manufactured by Hunan Beyond Medical Technology Co., Ltd. (hereafter, called “BEYOND Medical”).

All the information contained in this document is the legal property of BEYOND Medical and, unless specifically authorized in advanced and in writing by BEYOND Medical, the material contained in this document must not be reproduced in any means. Without a written authorization from BEYOND Medical, no institutions, companies, or individuals have the right to produce, sell, duplicate, or imitate the products contained herein. Doing so constitutes an infringement of the scope of our patent protections and constitutes a violation of the U.S. law.

BEYOND Medical reserves the right to pursue legal remedies against all such violations.

Contents

1. Introduction.....	1
1.1 Intended use	1
1.2 Warnings.....	1
1.3 Cautions	2
1.4 Contraindications	3
2. Model.....	4
3. Package Contents	4
4. Device Components.....	4
5. Device Symbols	5
6. Device Operation	6
6.1 First Use.....	6
6.2 Daily Use	7
7. Humidifier.....	7
7.1 Humidifier Composition	7
7.2 Humidifier Connection & Separation with the Host Unit.....	8
8. Using the SpO2 Kit.....	9
9. Parameter settings	10
9.1 Main Interface Screens	10
9.2 PFCurve interface	11
9.3 Parameter Setting Interface.....	11
9.4 System Setting Interface	12
9.5 Information Setting Interface.....	14
9.6 Epworth Interface	15
10. Prompt.....	17
11. Cleaning, Disinfection and Maintenances.....	17
11.1 Timing between Cleanings	17
11.2 Cleaning.....	18
11.3 Disinfection.....	18
11.4 Transferring to Another User.....	19
12. Troubleshooting	19
13. Specifications.....	21
14. Traveling with the Device.....	23
15. Service	24
16. Technical Support	24
17. Disposal	24
18. Warranty	24
19. EMC Requirements.....	25
Manufacturer:.....	28
U.S Agent:	29

1. Introduction

1.1 Intended use

The BEYOND ResPlus C-20A CPAP is designed for delivery of positive airway pressure to provide non-invasive ventilation for adult patients with respiratory insufficiency or obstructive sleep apnea (OSA) in home or hospital environment. Rx only: Federal law restricts this device to sale by or on the order of a licensed healthcare practitioner.

Please consult with a licensed health care professional prior to using this device. BEYOND Medical manufactures several accessories that are available to make your OSA treatment with this device as convenient and comfortable as possible. To ensure that you receive the safe and effective therapy, only use accessories manufactured by BEYOND Medical with this device.

1.2 Warnings

These warnings are meant to caution the user or operator of this device that there is a substantial risk of injury if these warnings are not followed.

⚠ These instructions are for reference only. They cannot replace the expert medical guidance from a licensed healthcare professional for the proper use of this device.

⚠ This device is not intended to be used to provide life support.

⚠ The proper operation of this device may be influenced or disturbed if any of the following conditions exist nearby:

- Electromagnetic fields exceeding 3V/m under the EN60601-1-2 test conditions.
- The operation of a high frequency device (diathermy).
- Electric shocks from a defibrillator or a short-wave therapeutic device.
- Radiation (such as, x-ray or CT).
- Electromagnetic field (such as, MRI).

⚠ Use only BEYOND Medical circuit accessories.

⚠ Do not wear the mask for longer than a few minutes while the device is not in operation.

⚠ Keep the device dry, ensure the tubing isn't tangled.

⚠ If you notice any damage to the device or experience any unusual performance (such as, harsh sounds or unfamiliar odors), quickly disconnect the power supply, empty the water tank, and stop using the device. Once the device is turned off, contact your BEYOND representative or local distributor.

⚠ The C-20A CPAP, like all CPAP devices, has a potential to allow users to rebreathe their own exhaled air. To reduce the chance of this possibility occurring, please observe the following precautions:

- Only use BEYOND Medical circuit accessories.
- Do not wear the mask for longer than a few minutes while the device is not in operation.
- Do not block or seal the vent holes in the exhalation port.

⚠ This device is not recommended to be used in combination with oxygen therapy. Sources of medical oxygen must be located more than 1 meter from this device to avoid the risk of fire.

⚠ Do not operate this device in the presence of flammable anesthetic mixtures, especially in combination with oxygen.

- ⚠ Do not operate this device in the presence of nitrous oxide and oxygen.
- ⚠ Keep away from toxic or hazardous steam.
- ⚠ Do not use this device if the room temperature is higher than 35°C (95°F). If the ambient temperature of the room is higher than 35°C (95°F), the air flow from the device may rise to exceed 40°C (105°F), which may cause damage to the user's airway.
- ⚠ Do not use this device in direct sunlight or near heating equipment. Doing so may increase the air temperature of the output to unsafe levels.
- ⚠ To avoid electrical shock, disconnect the power cord before cleaning. Do not immerse the device in fluid of any kind.
- ⚠ Contact your healthcare provider if symptoms of sleep apnea recur.
- ⚠ Regularly check the power cable and accessories for any damage or wear.
- ⚠ Disconnect the power supply before checking the device.
- ⚠ When using this device, make sure the mask is positioned above the height of the host unit. Failure to do so may cause any condensed water in the tubing to flow into the user's nose, creating the risk of possible suffocation.
- ⚠ Stop using this device if the humidifier is damaged.
- ⚠ Do not touch the heater plate after turning the device off. Let the heater plate cool off before touching. The plate will remain hot for several minutes after the power supply has been disconnected.
- ⚠ Do not add water hotter than 35°C (95°F).
- ⚠ Do not splash any water into the device when refilling the water tank.
- ⚠ Be sure that the device is in a place that cannot be accessed or touched by children, who could be entangled, injured, or strangled by the tube.
- ⚠ Appliance coupler is used as isolation means for the device, please do not position the device so that it is difficult to operate the coupler.
- ⚠ Do not attempt to modify this device without written authorization from the manufacture.
- ⚠ Do not place the device next to any curtains or similar obstruction. Curtains can block the airflow to the device, which may cause this device to overheat.
- ⚠ Do not block the air Intake Port. Doing so will interfere with the therapy.
- ⚠ The proper placement and positioning of the mask on the face is critical to the consistent operation of this device.
- ⚠ The local distributor of this device is available to provide technical support.
- ⚠ Do not perform any maintenance on the device while user is receiving the treatment.
- ⚠ All materials that come in contact with the human body have been tested for biocompatibility and meet the requirements of biological compatibility
- ⚠ Approved adapters are specified as part of the device.

1.3 Cautions

The following precautionary statements indicate conditions or actions that might damage the device or injure the user. Please read this section carefully.

- ⚠ Do not begin wearing the mask until the device has started to run normally.
- ⚠ Do not operate the device if the ambient temperature is outside of the operating temperature range (listed under Section 13). If the device has been exposed to temperatures that are above the operating temperature range, return the device to room temperature before use.

⚠ Do not immerse the device in liquid of any kind. Do not let any liquid enter into the device or into the filter near the air inlet.

⚠ The condensate water can damage this device. Make sure that the device returns to room temperature before use.

⚠ Be sure that the filter is seated properly in the device to ensure normal operation.

⚠ Any tar from smoking cigarettes near the device will stop the device from working properly.

⚠ If any liquid splashes onto the heater plate, disconnect the power supply and do not use it until the plate is completely dried.

⚠ Take all possible preventive measures to avoid water damage to the device.

⚠ Only use distilled water in the water tank. If any other type of liquid is put in the water tank, it may damage the humidifier and/or device, possibly endangering the health of the user.

⚠ Do not exceed the maximum water level mark on the water tank.

⚠ Do not splash the water into the device when filling the water tank.

⚠ Do not tilt the device. Keep the device level in order to avoid water flowing back into the device. If water does get inside the device, disconnect the power immediately and stop using it.

1.4 Contraindications

If the user has severe respiratory failure without spontaneous breathing, do not use the device. If any of the following conditions apply, consult the healthcare provider before using the device.

⚠ Absolute contraindications:

Pneumothorax or mediastinal emphysema; cerebrospinal fluid leak, traumatic brain injury, or pneumocephalus; shock caused by a variety of conditions before treatment; active epistaxis; upper gastrointestinal bleeding before treatment; coma or impaired consciousness that makes using the mask during therapy impossible; or giant vocal fold polyp, etc.

⚠ Relative contraindications:

Severe coronary heart disease complicated with left ventricular failure, acute otitis media, excessive respiratory secretions and weak cough, weak spontaneous breathing, nasal or oral tracheal intubation and tracheotomy, severe nasal congestion caused by a variety of conditions, lung bullae, and allergies to the breathing masks, etc.

⚠ The following side effects may occur during treatment:

- Dryness of the mouth, nose and throat
- Abdominal bloating
- Ear or sinus discomfort
- Eye irritation
- Skin irritation due to the use of a mask
- Chest discomfort

If you have any symptoms of discomfort, please contact your healthcare provider immediately.

2. Model

Model	Type	Main components	Working Mode	MaxPressure (cmH2O)
C-20A	Auto CPAP	Host Humidifier H10 SpO2 Kit S10(optional)	CPAP APAP	20

3. Package Contents

Item	Articles	Quantity	Remark
1	Host	1	Standard
2	Humidifier	1	Standard
3	Tubing	1	Standard
4	Mask	1	Standard
5	Adapter	1	Standard
6	User Manual	1	Standard
7	Air Filter	2	Standard
8	SpO2 Kit	1	Optional
9	Carrying Case	1	Standard
10	TF Card	1	Standard

4. Device Components

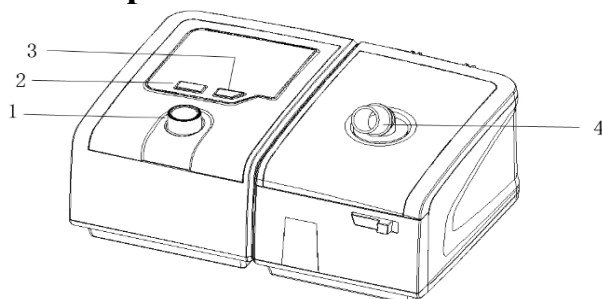

Fig. 4.1

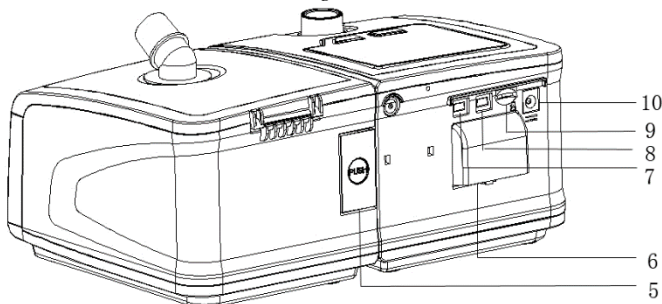



Fig. 4.2











1	Dial	Can be rotated in either direction or pressed to select.
2	Mute	Pressing this button turns off the voice alarm
3	On/Off Button	Pressing this button switches the device On or Off.
4	Air Outlet	This is the connection point for the tubing
5	Humidifier Separation Button	Pressing this button separates the humidifier from the host unit.
6	Air Inlet	The air filter is placed in this air exchange port.
7	SpO2 Port	This is the connection point for the SpO2 Kit
8	Data Port	This is the port for connecting to an external data device.
9	TF Card port	This is the port where a TF card is inserted.
10	Power Port	This is where the cord from the adapter is Connected.

 Do not remove the Dial cap. The metal rod connected to the Dial may come in contact with the external current, creating the risk of an electric shock. If the Dial cap falls off, contact the local distributor to purchase a replacement.

 In case of the failure of any of the buttons, contact the local distributor.

5. Device Symbols

These symbols are provided in the labeling papers to give users safety instructions, please read through their definitions carefully before using.

Symbol	Definition
	Warnings or Caution
	Type BF applied part
	Serial number of the product
	Date of manufacture
	Follow instructions for use
	The authorized EU-representative
	Manufacturer's Information
	CE Mark
	Degree of Protection Against Ingress of Water and Particulates
	Conforms to the Waste Electrical and Electronic Equipment /the Restriction of the Use of Certain Hazardous Substances in Electrical and Electronic Equipment

	Heat Warning
Rx Only	Caution: Federal law restricts this device to sale by or on the order of a licensed healthcare practitioner.

6. Device Operation

6.1 First Use

6.1.1 Place the device on a steady flat table where the settings are easy to reach and the information on the display can be clearly seen by the user.

⚠ Maintain at least 2 inches between the device and the wall to ensure that the air inlet is not obstructed.

⚠ When using the device, ensure that the surrounding air flows freely. Keep the device away from any heating and cooling devices (air conditioning vents, radiators, etc)

6.1.2 Place the air filter in the slot at the Air Inlet port.

6.1.3 Connect one end of the tubing into the Air Outlet.

6.1.4 Connect the mask into the other end of the tubing.

6.1.5 Connect the power adapter into the Power Port on the rear of the device.

6.1.6 Connect the device to mains power supply. The device will display the Standby Interface

6.1.7 Connect the power supply. Press the On/Off Button to start the device.

The Connections should appear as shown in *Fig 6.1* below:

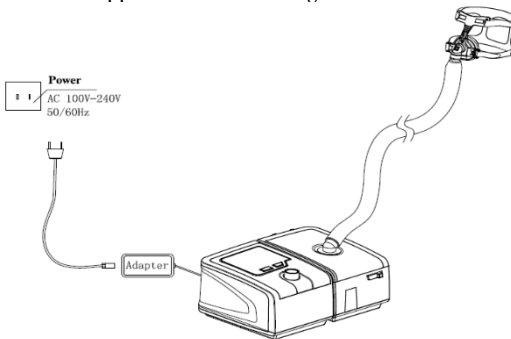

Fig.6.1

⚠ Put the device on a solid flat surface where the approach is not blocked, the displays are easy to see, and the controls are convenient to access. Be sure to place the device where it cannot fall easily. The device needs to be lower than the height of the bed.

⚠ Do not place the device in or on a container where water may gather.

⚠ Be sure to take preventive measures in order to avoid water damage to the device.

⚠ When water is in the humidifier, do not move the device, so as to avoid water entering into the device.

6.2 Daily Use

6.2.1 Assembling the Device

Connect the power supply and the tubing as listed for the first use (see above).
Connect the mask and the headgear according to the Mask User Manual (provided separately).

6.2.2 Adjust the Tubing

Adjust the tubing to make sure the tubing can move freely when the user is in a deep sleep. Adjust the mask and the headgear to make the user feel as comfortable as possible and prevent air from blowing into the user's eyes.

6.2.3 Start the Device Running

Press the On/Off Button. The device will begin to run and therapy data (such as, air pressure and temperature) will be shown on the display screen.

6.2.4 Humidifier Heating

If using the humidifier, it is recommended that the unit be used with the tubing which provided by BEYOND Medical to prevent leakage. If the humidifier is attached to the device but the user does not want to use the humidifier, turn the humidifier off.

6.2.5 Ramp Function

When using the Ramp Function, the device will begin at a low initial pressure and increase to the desired pressure setting in a steady rise over the time period selected by the user. After this function is selected, press the On/Off Button once, the device will start to run in accordance with the Ramp Function's settings. If the On/Off Button is pressed a second time, the device will cancel the Ramp Function and run at the selected pressure.

6.2.6 Turn Off the Device

When the mask is taken off, the device will stop running. The user then needs to turn off the device by unplugging the power supply.

7. Humidifier

In drier regions, prolonged use of the device may dry out the user's nasal passages, causing discomfort. This device is equipped with a humidifier to address this issue. When water is added to the humidifier and it is turned on, moisture will be added to the inhaled air to moisten the user's nasal passages.

7.1 Humidifier Composition

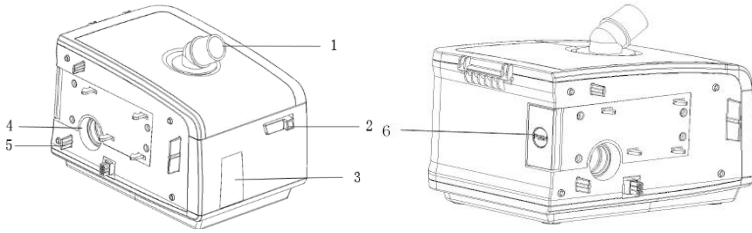

Fig.7.1

1	Air Outlet
2	Humidifier Cap Key
3	Water Checking Window
4	Air Inlet
5	Humidifier Connector
6	Humidifier Separation Key

7.2 Humidifier Connection & Separation with the Host Unit

7.2.1 Connect with the host unit

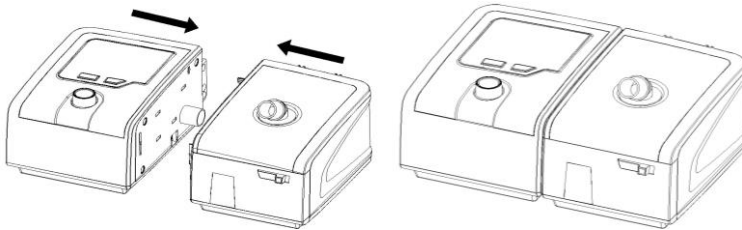



Fig.7.2.1a Before the connection Fig.7.2.1b After the connection

Push the host unit and humidifier together to connect them to each other. A “click” sound will be heard when they are properly connected.

 Push the humidifier to connect with the host completely.

7.2.2 Separate from the host unit

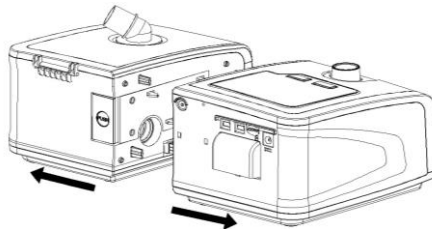
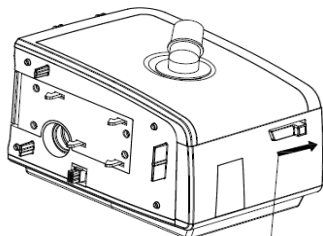

Fig.7.2.2

Press the Humidifier Separation Button while simultaneously pulling the humidifier apart from the host unit.

7.2.3 Adding water into the water tank

(1) Take out the water tank: move the humidifier cover by sliding the Humidifier Cap Key to the right side as shown in *Fig.7.2.3a below*. Then, open the humidifier cover to take out the water tank by grasping the tank with thumb and index finger as pictured in *Fig.7.2.3b*.



Humidifier Cap Key

Fig.7.2.3a

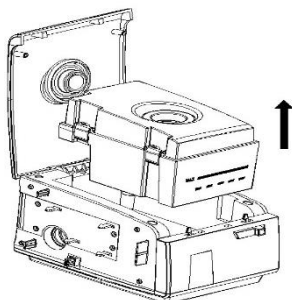

Fig.7.2.3b

(2) Add water through the Air Inlet port on top of the water tank. Make sure the water level does not exceed the Max line.

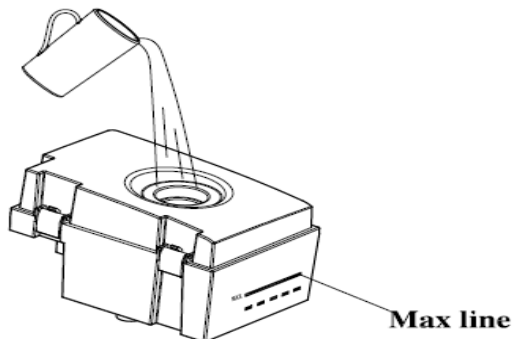

Fig.7.2.3c

- ⚠ In winter months, be sure to add warm water, but no hotter than 35°C (95°F).
- ⚠ Do not fill the water tank above the Max line.
- ⚠ Turn off the humidifier when the water tank is empty. Turn the device off before refilling water. Do not add water when the humidifier is in operation. Only add water when the humidifier has cooled down.
- ⚠ Do not let any water enter the host unit.

8. Using the SpO2 Kit

The SpO2 Kit consists with a SpO2 Probe, Adapter, and Connector. The SpO2 Kit is intended to be used for continuous, non-invasive functional arterial oxygen saturation (SpO2) and pulse rate monitoring for adults weighing more than 40 kg

(90 pounds).

The SpO2 Kit is immediately ready to use when it is connected to the main device via the Communications Port. Attach the Oxygen Probe sensor to the user's index finger (although other fingers can also be used).

The sampling frequency of the SpO2 signal is 50Hz, and the update frequency of the device is 1Hz. The value of SpO2 is calculated by the average of the previous eight pulse waveforms.

If the SpO2 Kit does not connect or is not performing correctly, the value of SpO2 will not be displayed on the Main Interface.

9. Interface Screens

9.1 Main Interface Screens

Connect the device properly to mains power supply with power cord and power adapter. The screen displays the Main Interface screen will appear as shown in Fig. 9.1 below.



Fig.9.1: C-20A Main Interface

△ Users can set the desired humidifier levels and the Ramp time on the Main Interface; the selectable values ranges are preset on the parameter interface.

△ When the humidifier is not connected to the device, the Humidifier setting icon in the main Interface is grayed and cannot be accessed.

△ SpO2 and Pulse Rate are only displayed when the SpO2 Kit (optional parts) is correctly attached.

Icon	Meaning
1	The TF card is inserted.
2	The device is working.
3	The Ramp function has been set.
4	The humidifier level has been set.

5		Indicates that the parameters setting interface is locked. When the device is connected to the power, its locked by default;.
---	---	---

9.2 PFCurve interface

Under main interface, rotate the “Dial” button to move the cursor onto the “PFCurve” indicator and press “Dial” button; the PFCurve Interface screen will appear on the display screen, as shown in Fig. 9.2 below.

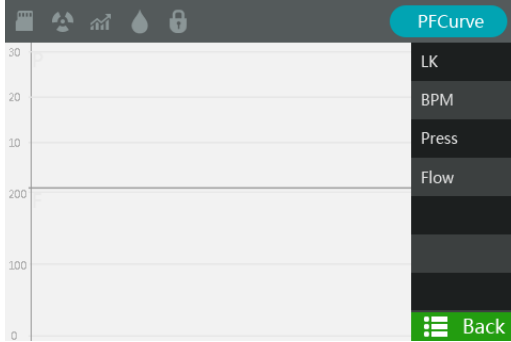

Fig.9.2: C-20A PFCurve Interface Screen

9.3 Parameter Setting Interface

Under the main interface, rotate the "Dial" button to move the cursor onto the “Parameters” icon. This will bring you to Parameter Setting Interface screen, as shown in Fig.9-3a below.

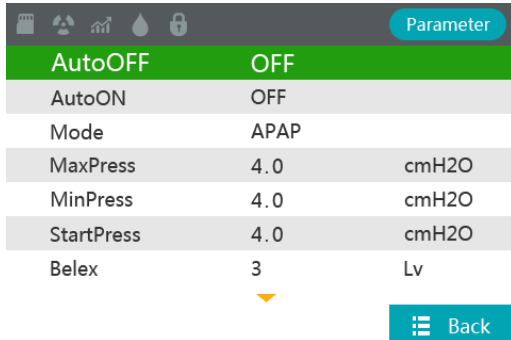

Fig.9.3a : C-20A Parameter Setting Interface Screen 1

Parameter		
AutoOFF	OFF	
AutoON	OFF	
Mode	APAP	
MaxPress	4.0	cmH2O
MinPress	4.0	cmH2O
StartPress	4.0	cmH2O
Belex	3	Lv

Back

Fig.9.3.b : Selected Status Screen

Parameter		
Ramp	10	min
Humidifier	5	Lv

Back

Fig.9.3c : C-20A Parameter Setting Interface Screen 2

9.4 System Setting Interface

Rotate the "Dial" button so that the cursor on the Main Interface screen is pointing at "System", then press the "Dial" button to enter into the System Setup Interface screen, as shown in Fig.9.4a .

System		
Time	12:14:56	
Date	2015-09-28	
BackLight	600	sec
Brightness	5	
Language	English	
PressUnit	cmH2O	
Reset		

Back

Fig.9.4a : System Setting Interface Screen 1

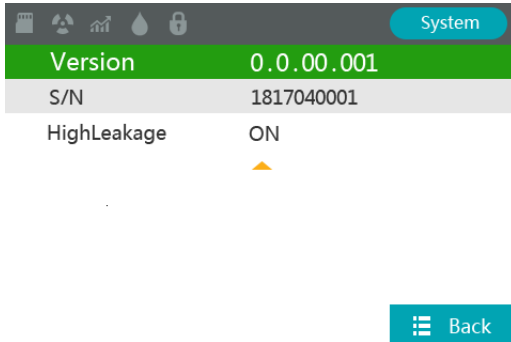

Fig.9.4b : System Setting Interface Screen 2

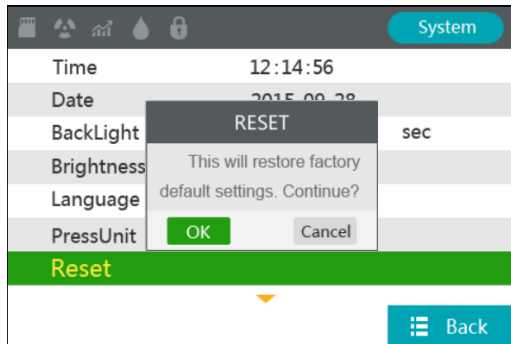

Fig.9.4c: System Setting Interface Screen
(with Reset Dialogue Box active)

Parameter	Setup range	Description
Time	h-m-s	This parameter sets the device's internal clock to track the time. This time will then be used to record the application information for users. This setting needs to be checked frequently to ensure continued accuracy.
Date	yyyy-mm-dd	This parameter sets the device's internal calendar to track the date. This date will then be used to record the application information for users. This setting needs to be checked frequently to ensure continued accuracy.
BackLight	30-600 sec	This parameter sets the length of time that the LCD display will be back lit. When the user sets a value, the backlight will turn off after the set time elapses.
Brightness	1-5 level	This parameter has a five-level range. The higher the level, the greater the screen brightness.
Language	Chinese-English	Can be switched from English to Chinese. Chinese language User Manuals can be requested from the manufacturer.
PressUnit	cmH ₂ O-hPa	Displayed values can be switched between "cmH ₂ O" and "hPa", as desired by the user.
Reset	-----	System Restore will return all system parameters back to the factory default values.
HighLeakage	OFF/ON	This parameter sets the high leakage prompt function for the device.

9.5 Information Setting Interface

Information		
UseCycle	1	Day
UseTime	24.5	hr
AvgPress	10.0	cmH ₂ O
TiPressure	9.5	cmH ₂ O
AvgLeakage	102.5	L/min
AHI	12.5	
UseDays	0	Day

▼

☰ Back

Fig.9.5a : C-20A Information Setting Interface 1



Fig.9.5b : C-20A Information Setting Interface 2

Parameter	Setup range	Description
UseCycle	1/7/30/90/180/365	The time period over which the following information items are calculated. Unit is "day".
UseTime	-----	The length of time that the device has been connected to the power supply. Unit is "hour".
AvgPress	-----	The average output pressure value of the device in the running state within the life cycle. Unit is "cmH ₂ O".
TiPressure	-----	The 95% output pressure value of the device in the running state within the life cycle, measured by usage time. Unit is "cmH ₂ O"
AvgLeakage	-----	The average leakage value of the device in the running state within the lifecycle. Unit is "L/min".
RunHrs	-----	The duration of running time after the device is shipped from factory. This value cannot be cleared.
AHI	-----	Apnea-hypopnea index of the device in the using cycle. Calculation method as Apnea-hypopnea frequency per hour
UseDays	-----	The device is connected to the power supply and continuously running for 4 hours or more it is counted as 1 day.

9.6 Epworth Interface

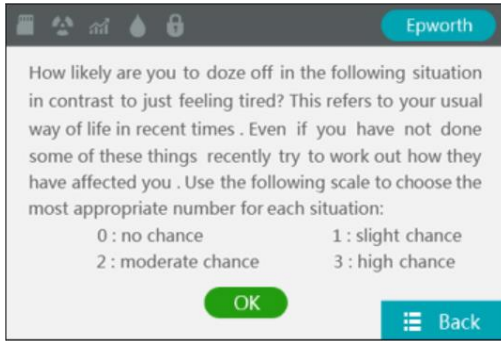

Fig.9.6a : Epworth Interface Screen 1

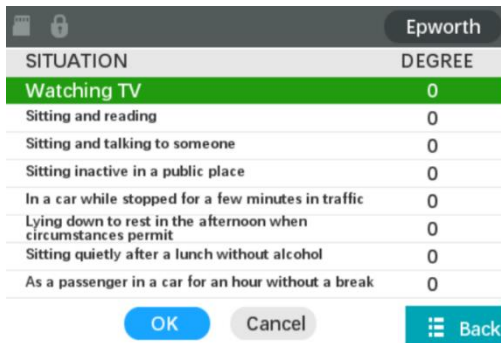

Fig.9.6b : Epworth Interface Screen 2

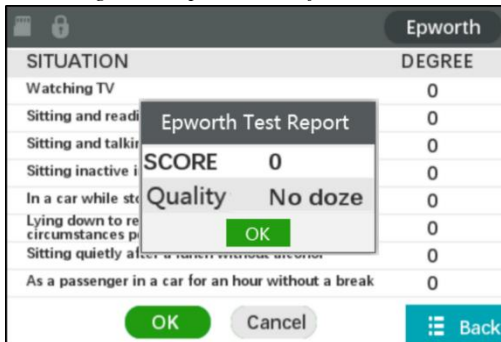

Fig.9.6c : Epworth Interface Screen 3

10. Prompt

Prompt Message	Description
Power Failure	If the power supply is disconnected while the device in the Working State , the device will provide a voice prompt via the buzzer for approximately 30 seconds. Pressing the "On/Off " Button or re-powering the device will stop the voice prompts. After power is returned to the device, it will return to the normal state.
LOW VOLTAGE!!	When the device detects that the adapter output voltage is below acceptable limits, the device will provide a voice prompt via the buzzer and "LOW VOLTAGE!!" will appear on the display. The warning sounds can be cancelled by pressing the Mute Button.
AIRWAY BLOCK!!	When the air flow of the device is blocked, the device will provide a sound prompt via the buzzer, and "AIRWAY BLOCK!!" will appear on the display. The warning sound can be cancelled by pressing the Mute Button.
HIGH LEAKAGE!!	When there is a leak in the device's breathing tube, the device will provide a sound prompt via the buzzer and "HIGH LEAKAGE!!" will appear on the display. The warning sound can be cancelled by the Mute Button.
HUMI FAILURE!	When the device is connected to the humidifier, the device is powered on, and the humidifier has been heating for 2 minutes, but the humidifier is not working, the device will provide a sound prompt via the buzzer and "HUMI FAILURE!" will appear on the display. The warning sound can be cancelled by pressing the Mute Button.
TF CARD FULL!	When the TF card that has been inserted into the device reaches its capacity limit, the device will provide a sound prompt via the buzzer and "TF CARD FULL!" will appear on the display. The audio prompt for this warning is a single tweet, it will only tweet once.

11. Cleaning, Disinfection and Maintenances

11.1 Timing between Cleanings

Based on hygienic reasons, under normal usage, it is recommended that the operator or user service and / or replace the parts as shown below:

- Clean the device, tube and filter before the device is used for the first time.
- Empty the water tank and clean it daily to prevent bacterial growth.
- Clean the air filter at least once every 2 weeks.
- Replace the air filter with a new filter at least every 3 months.
- Replace the mask with a new one every 3 months.

11.2 Cleaning

11.2.1 Cleaning the host and tubing

To avoid the possibility of electrical shocks and damage to the electrical system, unplug the power cord from the host unit before cleaning the device.

Clean the front panel and the outside of the case with a soft cloth that has been moistened with warm water or mild detergent. Before plugging in the power cord, make sure that the device is completely dry.

⚠ If the device is used by multiple users, the tubing and mask must be replaced between each use by a different user.

⚠ When cleaning the tubing and mask, please refer to the Mask User Manual.

11.2.2 Cleaning the water tank

Remove the water tank, open the upper lid, and clean the internal walls of the humidifier unit. Clean and rinse the water tank thoroughly.

Use mild liquid detergent to clean the unit and tank, then rinse with clean water.

After cleaning, wipe it clean and allow to dry naturally.

Please ensure that the unit seals tightly after each cleaning.

11.2.3 Clean and Replace the air filter

Clean the air filter thoroughly with warm water and mild detergent, then rinse off all detergent residues thoroughly with clean water. Before reinstalling the air filter, let it air dry completely. If air filter is damaged in any way, please replace it with new filter provided by authorized dealer.

1. Disconnect the device from the power source.
2. Remove the air filter enclosure from the device and remove the air filter.
3. Examine the air filter closely to ensure that it is clean and undamaged.
4. Wash the air filter in warm water with mild detergent as instructed above.
5. Reinstall the air filter

Caution:

⚠ Never install a wet air filter into the device.

⚠ Users should alternate between the two air filters included with the device.

This will ensure the air filter has the chance to sufficiently dry after each cleaning and before it is used in the device.

11.3 Disinfection

If you have followed the cleaning instruction correctly, you should not have to sterilize the device or its components. However, if the water tank or any other component is contaminated or if the device is used in a clinic setting, the device should be sterilized with any sanitizer gel available from a pharmacist.

⚠ Please note that the use of a sanitizing agent will damage the device's surface material and shorten its service life. Therefore, you should follow the sanitizer manufacturer's instruction for the type of material being cleaned.

⚠ Always use clean water to completely rinse the device components that come into direct contact with the user's skin, including the mask, headgear and tubes. Cleaning the material will help to prevent skin and respiratory tract infection that may be caused by any residual sanitizing solution.

11.4 Transferring to Another User

⚠ If device is to be used by another user, for sanitation purpose, the device components which come into close contact with this user’s skin, such as the mask, headgear, tube and air filter should be replaced with new ones. Alternatively, users can also follow the procedures listed in Section 11.3 “Disinfection”.

12. Troubleshooting

The below table lists some of the common problems the device might have and provides possible solutions to those problems. If these suggestions do not solve these problems, please contact your healthcare provider directly.

Phenomenon	Possible Causes	Troubleshooting
Nothing displays on the screen or the Main Interface screen does not appear after turning the device on.	The power supply is not connected properly.	Disconnect the power plug and re-connect it.
The device beeps after turning on.	The power supply is not connected properly.	Disconnect the power plug and re-connect it.
The device fails to stop automatically after removing the mask.	“Auto OFF” function is off.	Set the “Auto OFF” function to “ON”.
Nose and/or throat are dry and/or irritated when using this device.	The air is dry in the room.	Turn up the humidifier level or consult your doctor.
Dry mouth and throat.	Likely because the user sleeps with his or her mouth opened so that the pressurized air goes through the mouth, which leads to dryness of the nasal passages and throat.	The setting pressure may be too low. You may also want to consult your doctor .
Eye irritation or dryness.	The model or size of the mask may not be suitable. The mask may also be positioned incorrectly causing air to blow into the user’s eyes.	Adjust the mask position and the headgear’s tightness. Consult your doctor to replace the mask. If the mask is old or broken, replace immediately. Try another mask model.
Face reddening or inflamed.	The headgear is too tight. The mask model or size may not be suitable. The user	Loosen the headgear and insure proper fit. Consult your doctor.

	may be allergic to the materials of the mask.	
Water in the mask	Room temperature is too low or (if the humidifier is being used) output air can condense in the tube and collect in the mask.	Lower the humidifier setting, increase the room temperature, or place a towel or blanket over the tube to maintain the temperature of the output air flow.
Nasal, sinus, or ear pain	Inflammation in sinus or middle ear.	Stop using the device immediately and contact your doctor.
Obstructive Sleep Apnea-Hypopnea Syndrome recrudescence (<i>e.g.</i> : daytime sleepiness)	The required treatment pressure may have changed due to your weight, nasal obstruction, drinking or some other reasons.	Consult your doctor.
Air output is too hot.	The air filter is either clogged with dirt or the air inlet is otherwise blocked. The device might also be too close to wall, curtains or other obstructions to the air flow around the device.	Check and clean the air inlet, replace if necessary. Reposition the device to a place that is at least 2 inches away from the wall, curtain or other obstructions.
No airflow output	Device malfunction	Contact your device supplier.
The air flow output is too low	If the “Ramp” function is on, it takes time for air flow to rise from the initial pressure to the treatment pressure. The air inlet may also be blocked.	Turn off or change the settings of the Ramp feature. Check and clean the air inlet or replace the air filter.
The blower is always at an abnormally high rotation rate.	The device is leaking air.	Contact your device supplier.
The device doesn’t work when it is turned on.	Device malfunction.	Contact your device supplier
The device works but the pressure in the mask is obviously different from the setting pressure.	Tubes are either leaking or the device is malfunctioning.	Check to see if the tubing is connected properly. If problem persists, contact your device supplier.

The device can only output air at low pressure.	The air filter or air inlet is blocked, or the treatment pressure has been set too low. If the Ramp function is on, it takes time for air flow to rise from the initial pressure to the treatment pressure.	Replace the air filter and clean the air inlet. You may also need to turn off or change the settings of the Ramp feature.
The device is excessively loud.	The tube isn't connected properly. The mask or tubing may also be leaking.	Reconnect the tubing and ensure there are no leaks in the tubing.
The pressure can't be set.	The Ramp feature is on.	Turn off the Ramp feature, then re-set the pressure.

⚠ If the problem can't be eliminated immediately by the above suggestions, please contact your device supplier for repair.

⚠ To avoid more injuries or faults, please don't use the device when any of these problems persist.

⚠ Opening this device voids the warranty. Only professionals certified by BEYOND Medical are authorized to open the device.

13. Specifications

Environmental

	Operating	Storage
Temperature	5°C to 35°C (41°F to 95°F)	-20°C to 55°C(-13°F to 158°F)
Humidity	15% to 93% (no condensation)	15% to 93% (no condensation)
Atmospheric Pressure	700 to 1060 hPa	700 to 1060 hPa

Physical

Dimensions	165mm*200mm*120mm, 280mm*200mm*140mm(with humidifier)
Weight	1.2Kg,2.2Kg (with humidifier)

Electrical

Power adapter	Input: AC100-240V, 50/60Hz, 1.8Amax Output: DC24V, 3.75A
Type of protection Against Electric Shock	Class II Equipment
Degree of protection Against Electric Shock	Type BF applied part

Degree of protection Against Ingress of Water	IP22
Mode of operation	Continuous
Applied part	SpO2 Probe, Tubing, Mask

Noise level

The A-weighted sound pressure level does not exceed 30dBA, the A-weighted sound power level does not exceed 38dBA, when the device is working at the pressure of 10 cmH₂O.

Pressure Accuracy

According to the pressure accuracy of ISO 80601-2-70:2015 standard.

Pressure Range:

- CPAP:4 to 20 cmH₂O (in 0.5 cmH₂O increments), ≤ 30 cmH₂O under single fault conditions.

Pressure display accuracy:

± (0.5 cmH₂O +4% of the actual reading)

Pressure stability:

Static	Dynamic (4 to 20 cmH ₂ O)
±0.5cmH ₂ O	≤ 2cmH ₂ O

Maximum Flow:

According to the maximum flow of ISO 80601-2-70:2015 Standard

CPAP

	Test pressure (cmH ₂ O)				
	4	8	12	16	20
Average flow at the user connection port (l/min)	100	120	120	120	120

Note: all test data were carried out under conditions with the humidifier and 22mm tube.

Ramp: The ramp time ranges from 0 to 60 minutes.

SpO₂ Range: 0 ~ 100%.

The margin of error for SpO₂ between 70% and 100% is±3%. No strict accuracy requirements for SpO₂ below 70%.

Pulse Rate

Range: 40 ~ 240 BPM

Margin of Error: ±3%

Tubing

Length: 1.8m

The Form and the Dimensions of the Patient Connection Port

The 22 mm conical air outlet complies with ISO 5356-1.

Filter

Dimension : 45mm*33mm*10mm

Output air flow temperature:	<40°C(104°F)
Humidity output	Not less than 10mg H ₂ O/L Measured conditions: Max flow, 35°C(95°F), 15% relative humidity.
Pressure drop caused by humidifier	< 1cmH ₂ O (with the flow rate of 60 LPM)
Leaking under maximum working pressure:	<25mL/min (Together with the tubing)
Adaptability	< 20mL/kPa (Together with the tubing)
Capacity	300ml

Humidifier

Tested according to EN ISO 8185 standard or equivalent methods.

Pneumatic Diagram

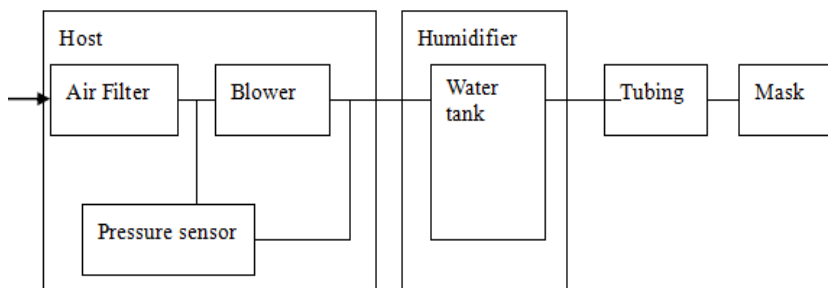

14. Traveling with the Device

1. Only use the BEYOND Medical carrying case when transporting the device and accessories. The device should never be placed in checked baggage.
2. This device operates on power supplies of between 100 - 240 V and 50 / 60 Hz. It can be used in any country in the world, no special adjustments are necessary. However, you will need to find out what type of power sockets are standard in your destination. Power socket adaptors are available separately anywhere you can purchase general electronics.
3. **Security Check Points:** For convenience at security check points, there is a note on the bottom of the device stating that it is medical equipment. It may be helpful to bring this manual along with you to help security personnel better understand the device.

⚠ Empty the water tank of the humidifier and allow it to dry completely before packing the device for your trip. This will prevent any remaining water from entering into the device.

⚠ Be sure to use the device at the proper elevation setting, failure to do so could result in airflow pressures different than the prescribed setting. Always verify both your actual elevation and the device's elevation setting when using the device in a different location.

⚠ If the device is used when the atmospheric pressure is outside of the stated range (See Section 9), the accuracy of the leakage alert will be negatively affected.

15. Service

The device does not require any routine servicing.

⚠ If you notice any unexplained changes in the performance of the device, if it is making unusual or harsh sounds, if it has been dropped or mishandled, if the enclosure is broken, or if water has entered the enclosure, you must discontinue use and contact your home healthcare provider.

⚠ If the device malfunctions, contact your home healthcare provider immediately. Never attempt to open the enclosure of the device. Repairs and adjustments must only be performed by service personnel that have been authorized by BEYOND Medical. Unauthorized service could cause injury, invalidate the warranty, and/or result in costly damage.

⚠ If necessary, contact your local authorized dealer or BEYOND Medical for technical support and documents.

16. Technical Support

Please contact BEYOND Medical directly if you need the circuit diagram of the device or the list of components for certain purposes (such as, maintenance or connection to other equipment). BEYOND Medical will provide the circuit diagram and/or other technical documents in whole or in part according to your needs.

17. Disposal

When the device reaches the end of its service life, please dispose of the device and its packaging in accordance with local laws and regulations.

18. Warranty

From the date of purchase, the manufacturer provides a one-year limited warranty for the host unit and a 3-month limited warranty for the tubing, mask and humidifier. This limited warranty is only available to the initial consumer. It is not transferable. For one year (or 3-month) from the original date of purchase, BEYOND Medical will repair or replace any parts of this appliance that prove to be defective in materials or workmanship when such appliance is installed, used and maintained in accordance with the provided instructions.

Exclusions This warranty does not cover:

1. Product with original serial numbers that have been removed, altered or cannot be readily determined;
2. Any damage caused as a result of improper use, abuse, excessive usage, modification or alteration of the device;
3. Repairs carried out by any service organization that has not been expressly authorized by BEYOND Medical to perform such repairs;
4. Any damage or contamination due to cigarette, pipe, cigar or other smoke;
5. Any damage caused by exposure to ozone, activated oxygen or other gases;

6. Any damage or contamination due to insect infestation; and
7. Any damages caused by external causes such as accidents, fires, or acts of God.

Considering the life of components and safety, medical devices should not be used longer than 5 years. Expired products should be discarded according to corresponding local laws and regulations.

DISCLAIMER OF IMPLIED WARRANTIES; LIMITATION OF REMEDIES

CUSTOMER’S SOLE AND EXCLUSIVE REMEDY UNDER THIS LIMITED WARRANTY SHALL BE PRODUCT REPAIR OR REPLACEMENT AS PROVIDED HEREIN. CLAIMS BASED ON IMPLIED WARRANTIES, INCLUDING WARRANTIES OF MERCHANTABILITY OR FITNESS FOR A PARTICULAR PURPOSE, ARE LIMITED TO ONE YEAR OR THE SHORTEST PERIOD ALLOWED BY LAW, BUT NOT LESS THAN ONE YEAR. BEYOND MEDICAL SHALL NOT BE LIABLE FOR CONSEQUENTIAL OR INCIDENTAL DAMAGES SUCH AS PROPERTY DAMAGE AND INCIDENTAL EXPENSES RESULTING FROM ANY BREACH OF THIS WRITTEN LIMITED WARRANTY OR ANY IMPLIED WARRANTY. SOME STATES DO NOT ALLOW THE EXCLUSION OR LIMITATION OF INCIDENTAL OR CONSEQUENTIAL DAMAGES, OR LIMITATIONS ON THE DURATION OF IMPLIED WARRANTIES, SO THESE LIMITATIONS OR EXCLUSIONS MAY NOT APPLY TO YOU. THIS WRITTEN WARRANTY GIVES YOU SPECIFIC LEGAL RIGHTS. YOU MAY ALSO HAVE OTHER RIGHTS THAT VARY FROM STATE TO STATE.

19. EMC Requirements

**Guidance and Manufacturer's Declaration: Electromagnetic Emissions
Guidance and Manufacturer's Declaration: Electromagnetic Emissions**

This device is intended for use in the electromagnetic environment specified below. The user of the device should ensure that it is used in such an environment.

Emissions test	Compliance	Electromagnetic environment-guidance
RF emissions CISPR11	Group 1	The device uses RF energy only for its internal function. Therefore, its RF emissions are very low and are not likely to cause any interference in nearby electronic equipment.

RF emissions CISPR11	Class B	This device is suitable for use in all establishments including domestic establishments and those directly connected to the public low-voltage power supply network that supplies buildings used for domestic purposes
Harmonic emissions IEC61000-3-2	Class A	
Voltage fluctuation /flicker emissions IEC61000-3-3	Complies	

Guidance and Manufacturer's Declaration - Electromagnetic Immunity

This device is intended for use in the electromagnetic environment specified below. The user of the device should make sure that it is used in such an environment.

Immunity test	IEC60601 test level	Compliance level	Electromagnetic environment-guidance
Electrostatic discharge (ESD) IEC61000-4-2	±6KV contact ±8KV air	±6KV contact ±8KV air	Floor should be wood, concrete or ceramic tile. If floors are covered with synthetic material, the relative humidity should be at least 30%.
Electrical fast transient /pulse IEC61000-4-4	±2KV for power supply lines ±1KV for input/output line	±2KV for Main power line ±1KV for input/output lines	Mains power quality should be that of a typical home or hospital environment
Surge IEC61000-4-5	±1K differential mode ±2KV common mode	±1KV differential mode ±2KV common mode	Mains power quality should be that of a typical home or hospital environment
Voltage dips, short interruptions and voltage variations of the input power IEC61000-4-11	<5% U_T (>95% dip in U_T), for 0.5 cycle 40% U_T (60% dip in U_T), for 5 cycles 70% U_T (30% dip in U_T) for 25 cycles <5% U_T	<5% U_T (>95% dip in U_T), for 0.5 cycle 40% U_T (60% dip in U_T), for 5 cycles 70% U_T (30% dip in U_T) for 25 cycles <5% U_T (>95% dip in U_T)	Mains power quality should be that of a typical commercial or hospital environment. If the user of the device requires continued operation during power mains interruptions, it is recommended that the device be powered from an uninterruptible power supply or from a battery.

	(>95% dip in U_T) for 5 s	for 5 s	
Power frequency (50/60Hz) magnetic field IEC61000-4-8	3A/m	3A/m	Power frequency magnetic fields should be at levels characteristic of a typical location in a typical hospital or home environment.
<i>Note: U_T is the a.c. mains voltage prior to application of the test level.</i>			

Guidance and Manufacturer's Declaration - Electromagnetic Immunity

This device is intended for use in the electromagnetic environment specified below. The user of the device should make sure that it is used in such an environment.

Immunity test	IEC60601 test level	Compliance level	Electromagnetic environment-guidance
Conducted RF IEC61000-4-6 Radiated RF IEC61000-4-3	3Vrms 150kHz to 80MHz 3V/m 80MHz to 2.5GHz	3Vrms 3V/m	Portable and mobile RF communications equipment should be used further away from any part of the device (including cables) than the recommended separation distance calculated from the equation applicable to the frequency of the transmitter. Recommended separation distance $d = 1.2\sqrt{P}$ $d = 1.2\sqrt{P}$ 80MHz to 800MHz $d = 2.3\sqrt{P}$ 800MHz to 2.5GHz \sqrt{P} is the maximum normal output power of the transmitter, its unit is Watt (W) and d is the recommended separation distance, its unit is meter (m). Measured magnetic field strengths from a fixed RF transmitter should be less than the compliance level in each frequency range b. Interference may occur in the vicinity of equipment marked with the following symbol: 
<i>Note 1: At 80 MHz and 800 MHz, the higher frequency range applied.</i> <i>Note 2: These guidelines may not apply in all situations. Electromagnetic propagation is affected by absorption and reflection of the structures, objects and people.</i> a. Field strengths from fixed transmitters, such as base stations for radio (cellular / cordless) telephones and land mobile radios, amateur radio,			

AM and FM radio broadcast and TV broadcast cannot be predicted theoretically with accuracy. To assess the electromagnetic environment due to fixed RF transmitters, an electromagnetic site survey should be considered. If the measured field strength in the location in which the device is used exceeds the applicable RF compliance level above, the device should be observed to verify normal operation. If abnormal performance is observed, additional measures may be necessary, such as re-orienting or relocating the device.

- b. *Over the frequency range 150 kHz to 80 MHz, the field strengths should be less than 3 V/m.*

Recommended separation distances between portable and mobile RF communications equipment and the device:

The device is intended for use in an electromagnetic environment in which radiated RF disturbances are controlled. The customer or the user of the device can help prevent electromagnetic interference by maintaining a minimum distance between portable and mobile RF communications equipment (transmitters) and the device as recommended below, according to the maximum output power of the communications equipment.

Rated maximum output of transmitter (W)	Separation Distances According to Frequency of Transmitter		
	150 kHz ~ 80 MHz $d = 1.2\sqrt{P}$	80 MHz ~ 800 MHz $d = 1.2\sqrt{P}$	800 MHz ~ 2.5 GHz $d = 2.3\sqrt{P}$
0.01	0.12	0.12	0.23
0.1	0.38	0.38	0.73
1	1.2	1.2	2.3
10	3.8	3.8	7.3
100	12	12	23

For transmitters rated at a maximum output power not listed above, the recommended separation distance (d) in meters(m) can be estimated using the equation applicable to the frequency of the transmitter, where P is the maximum output power rating of the transmitter in watts(W) according to the transmitter manufacturer.

Note 1: At 80 MHz and 800 MHz, the higher frequency range applied.

Note 2: These guidelines may not apply in all situations. Electromagnetic propagation is affected by absorption and reflection of the structures, objects and people.

Manufacturer:

Hunan Beyond Medical Technology Co.,Ltd.

Address: BEYOND ZONE, LIJIACUN RD,

XUESHI STREET, CHANGSHA, HUNAN 410208,

CHINA.ina.

Contact Number: +86-731-82564299
www.csbeyond.com

U.S Agent:

United Source LLC

Email: BEYOND@united-source.com

**Address: 1521 Concord Pike, Suite 301, Wilmington,
DE, 19803, USA**

VersionNo.: U.S./20220407/A2